

Captive Transit Mounts



A universal mounting, popular in a wide range of applications. Cost Effective, High Performing and Easy to Install. The rubber is used in shear compression providing optimum performance and offers vibration reduction of up to 95% in all axis. The metal top cap provides protection from contamination such as Oil and Fuel. Load Ratings from 20kg to 5,000kg.

Captive Transit Mounts are designed with an integral overload stop to control movement of the mounted equipment, during transit, and also provide a failsafe arrangement to control shock loads. Suitable for both Mobile and Static applications.

Advantages:

- Failsafe Design – Ideal for Mobile Equipment
- High Performance Vibration Reduction
- Easy to Install
- Protection from Contamination

Applications:

- Generating Sets
- Diesel Engines
- Marine Engines
- Construction and Plant Equipment
- Pumps and Compressors
- Industrial & Commercial Vehicles



TO ORDER PLEASE CALL : 888-625-8944
1515 Matheson Blvd., East, Unit C-10,
Mississauga, Ontario L4W 2P5

Captive Transit Mounts

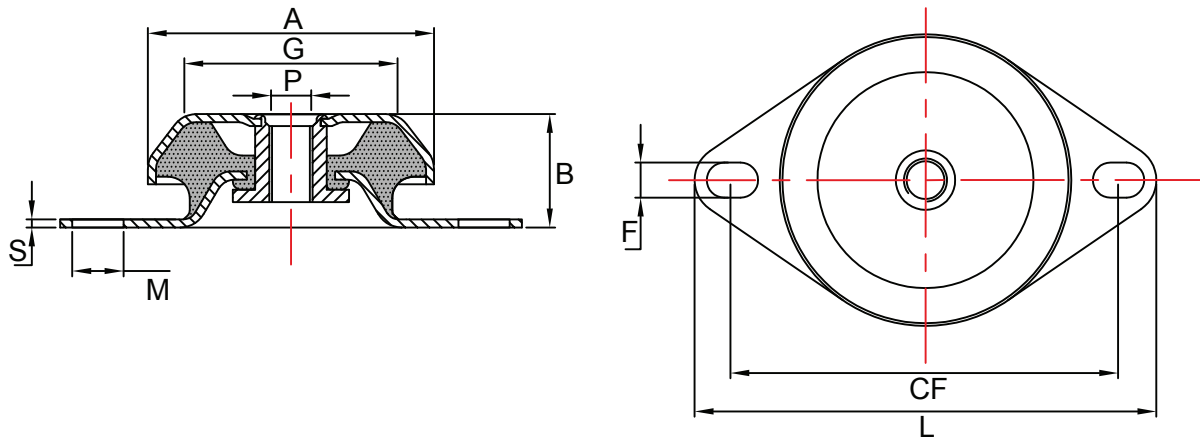

Part No	A	B	P	F x M	CF	G	L	S
CTM4823	48	23	M6/M8	6.1ø	68	34	84	2.0
CTM-R*	64	34	M12	9.5ø	76	47	93	2.5
CTM6335	63	35	M10 / M12	9 x 14	76 - 90	50	110	2.5
CTM6535	65	35	M12	15 x 11	100	45	120	3.0
CTM7730	77	30	M10 / M12	9ø	108 - 110	60	135	3.0
CTM8335	83	35	M10 / M12	11ø	108 - 110	65	135	3.0
CTM9245	92	45	M12	10.5ø	110	73	128	3.0
CTM9335	93	35	M10 / M12	10ø	122 - 124	70	144	2.5
CTM10638	106	38	M12 / M16	12.5 x 19	138-146	80	171	4.0
CTM10642	106	42	M12 / M16	12.5 x 19	138-146	80	171	4.0
CTM10850	108	50	M16	16.5ø	160	83	190	5.0
CTM11548	115	48	M16	16ø	160	85	190	4.0
CTM12142	121	42	M12 / M16	13.5ø	150 - 163	92	190	4.0
CTM12548	125	48	M16	14 x 11	150 - 163	99	192	4.0
CTM14448	155	48	M16	14 x 11	176-188	120	216	4.0
CTM14453	155	53	M16	14 x 11	176-188	120	216	4.0

*Manufactured from High Damped Rubber compound

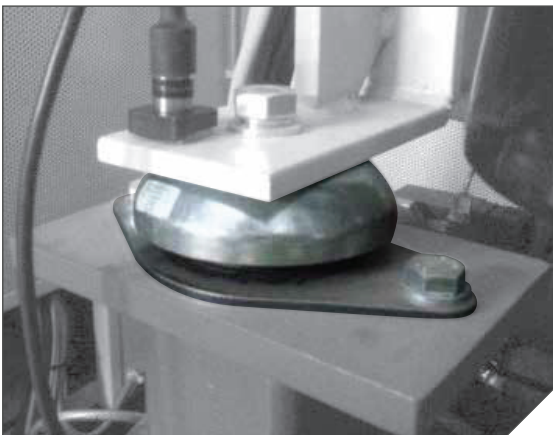

Max compression load in Kg deflection in mm.

This information is for guidance only. Customers are recommended to contact us for further technical information on products and applications. We reserve the right to alter specifications or withdraw products without notice.



TO ORDER PLEASE CALL : 888-625-8944

1515 Matheson Blvd., East, Unit C-10,
Mississauga, Ontario L4W 2P5

CTM4823

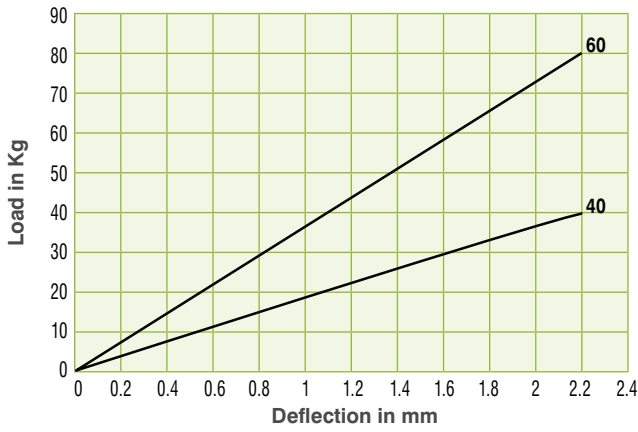

CTM-R

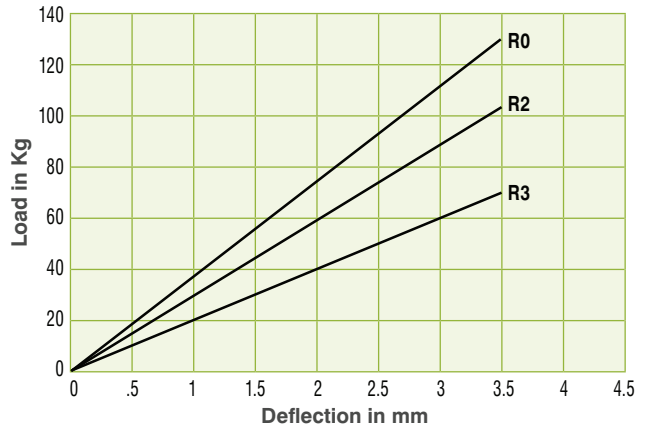

CTM6335

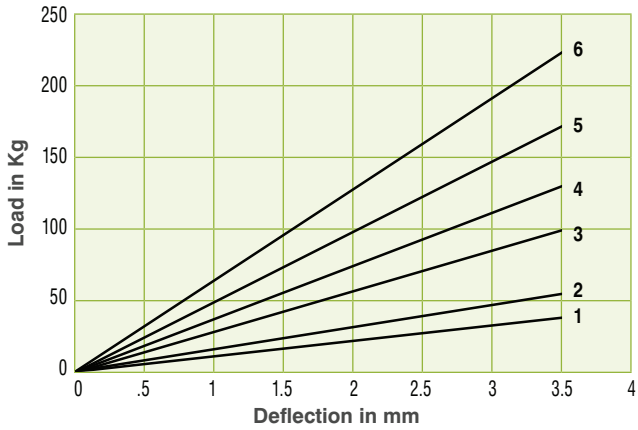

CTM6535

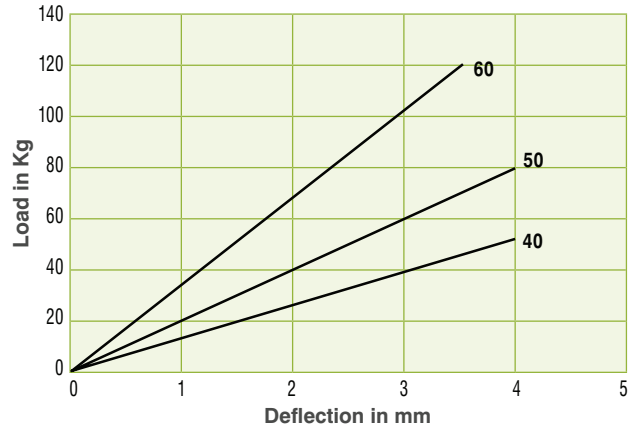

CTM7730

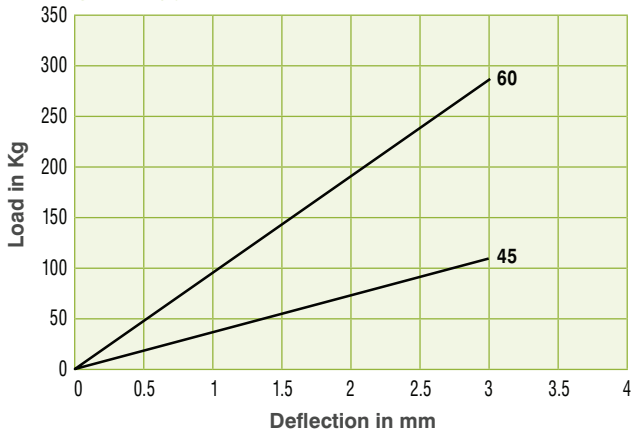

CTM8335

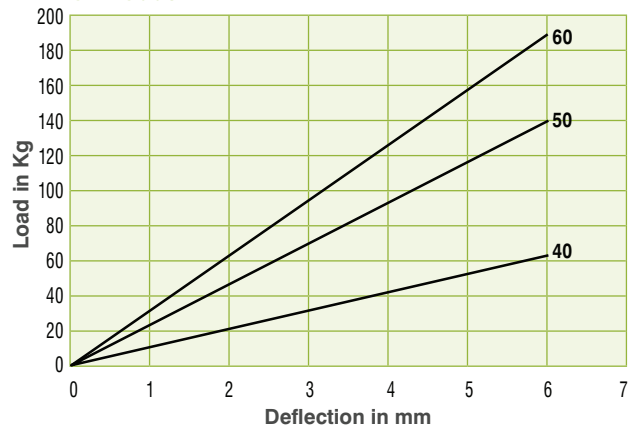

CTM9245

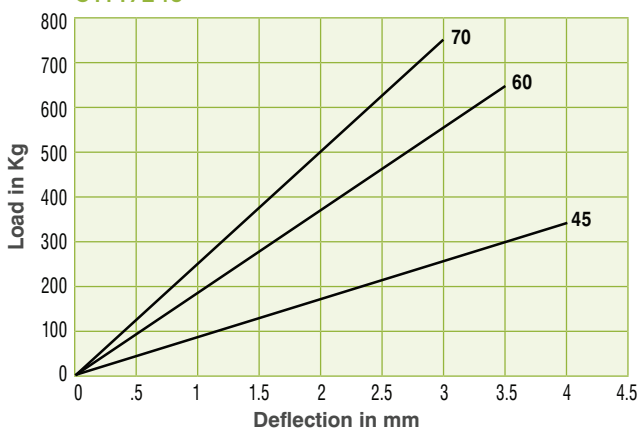

CTM9335

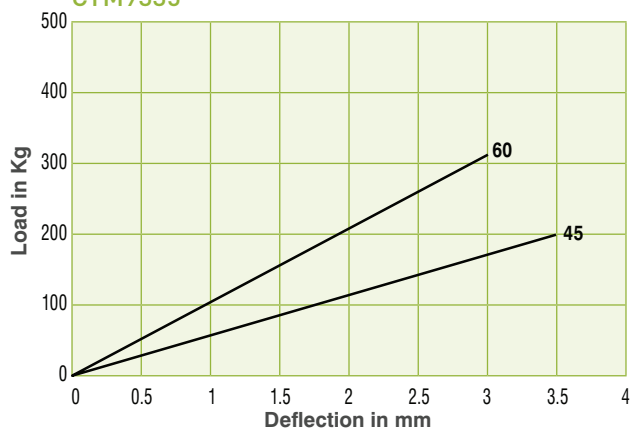

Max compression load in Kg deflection in mm.
 This information is for guidance only. Customers are recommended to contact us for further technical information on products and applications.
 We reserve the right to alter specifications or withdraw products without notice.



TO ORDER PLEASE CALL : 888-625-8944

1515 Matheson Blvd., East, Unit C-10,
 Mississauga, Ontario L4W 2P5

CTM10638

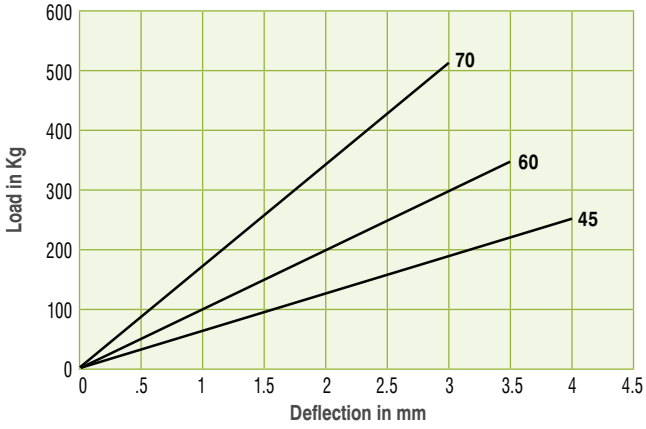

CTM10642

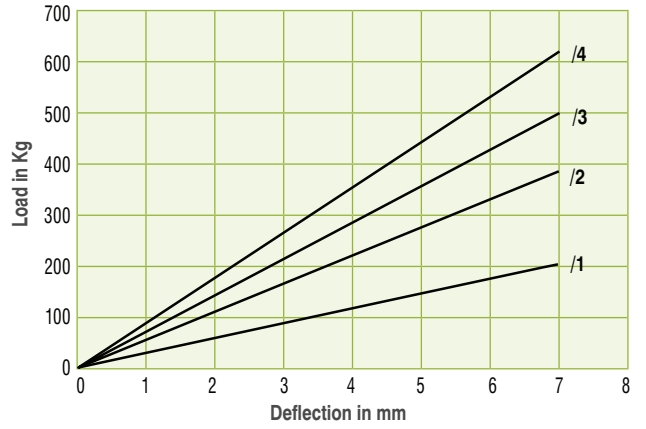

CTM10850

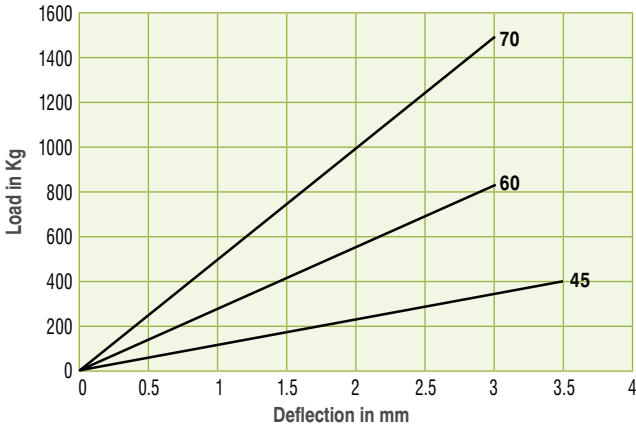

CTM11548

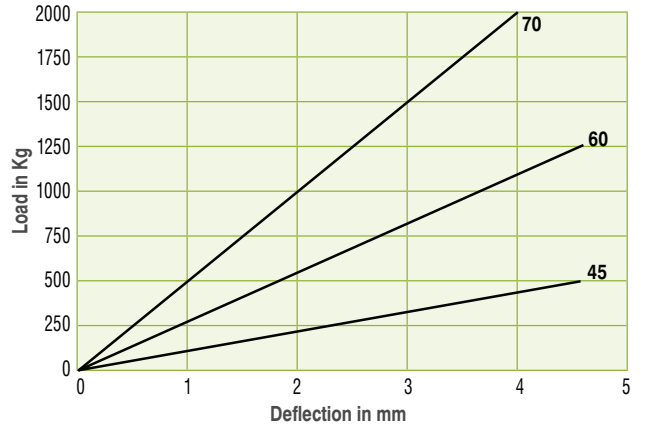

CTM12142

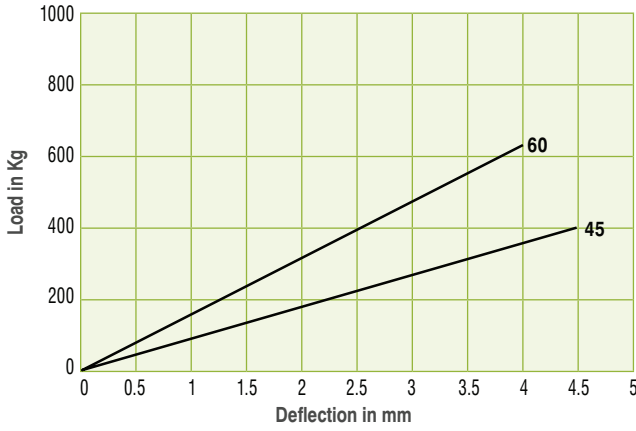

CTM12548

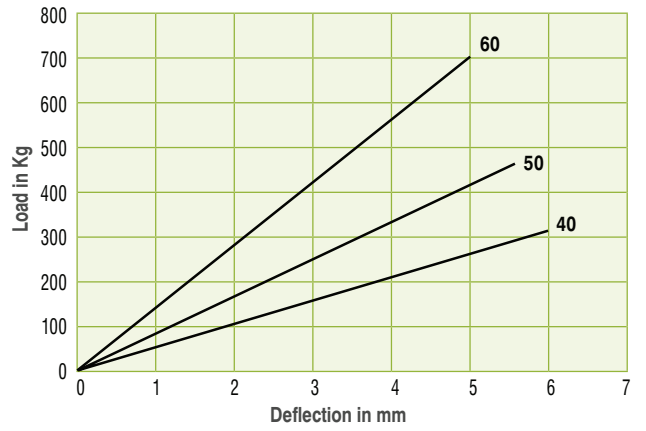

CTM14448



CTM14453

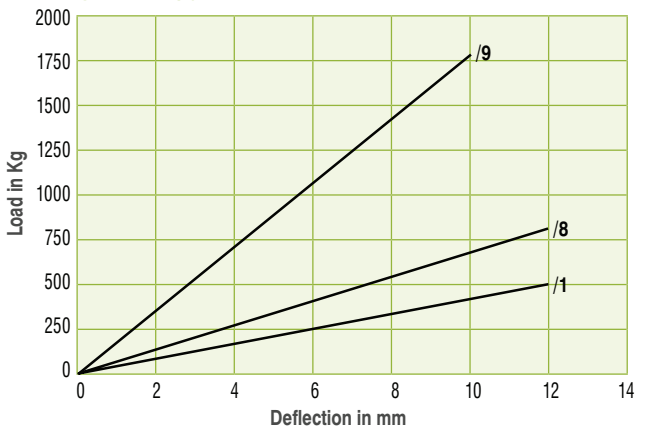

Max compression load in Kg deflection in mm.
 This information is for guidance only. Customers are recommended to contact us for further technical information on products and applications.
 We reserve the right to alter specifications or withdraw products without notice.



TO ORDER PLEASE CALL : 888-625-8944
 1515 Matheson Blvd., East, Unit C-10,
 Mississauga, Ontario L4W 2P5